

CHARACTERISTICS

- Pilot hole in concrete needed, thread is created by the anchor during the Installation process.
- Use for high loads.
- Assessed for 2 installation depths and 3 for $\varnothing 10$.
- Use in cracked and non-cracked concrete.
- Comply with guideline VdS CEA 4001:2021-01(07) "Guidelines for sprinklers systems. Planning and installation"
- Suitable when reduced edge distances or spacing required.
- Qualified for static and cuasi-static.
- Easy installation.
- Installation through the fixture.
- Reusable
- Removable, leaving concrete surface flat.
- Variety of lengths and sizes, assembly flexibility.
- VdS available from $\varnothing 6$ to $\varnothing 18$
- Available in INDEXcal

BASE MATERIAL



SIZE RANGE

$\varnothing 5 - \varnothing 18$

DRILL CONDITION



DRY

WET

FLOODED

MAXIMUM LOADS RECOMMENDED FOR CRACKED AND UNCRACKED CONCRETE [kg]

APPLICATION

- Structural fixings in cracked and uncracked concrete subject to dry internal conditions.
- Glazing, windows and storefronts
- Racking and shelving
- Attaching railings, handrails and ledgers
- Fixings wood structures in concrete

ASSESSMENTS





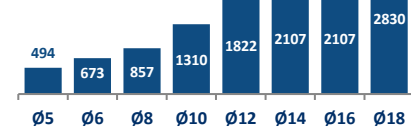















TH



APPLICATION EXAMPLES



1. RANGE						
ITEM	CODE	SIZES	PHOTO	DESCRIPTION	MATERIAL	COVERING
1	THE	Ø5 - Ø18		Hexagonal head with flange screw anchor	Carbon steel, ATLANTIS coating	
2	TFE	Ø5 - Ø18		Hexagonal head with flange screw anchor	Carbon steel, zinc plated coating ≥ 5 µm	
3	TFN	Ø14		Hexagonal head screw anchor	Carbon steel, zinc plated coating ≥ 5 µm	
4	THA	Ø5 - Ø10		Countersunk screw anchor	Carbon steel, ATLANTIS coating	
5	THT	Ø6		Truss head screw anchor	Carbon steel, ATLANTIS coating	
6	THP	Ø5 - Ø8		Pan head screw anchor	Carbon steel, ATLANTIS coating	
7	TFF	Ø6		Rod hanger internal thread screw anchor	Carbon steel, zinc plated coating ≥ 5 µm	
8	TFM	Ø6		Hexagonal head with flange and with external thread screw anchor	Carbon steel, zinc plated coating ≥ 5 µm	
9	TFS	Ø6 - Ø10		Stud head screw anchor	Carbon steel, zinc plated coating ≥ 5 µm	

2. INSTALLATION DATA

2.1. INSTALLATION DRAWING

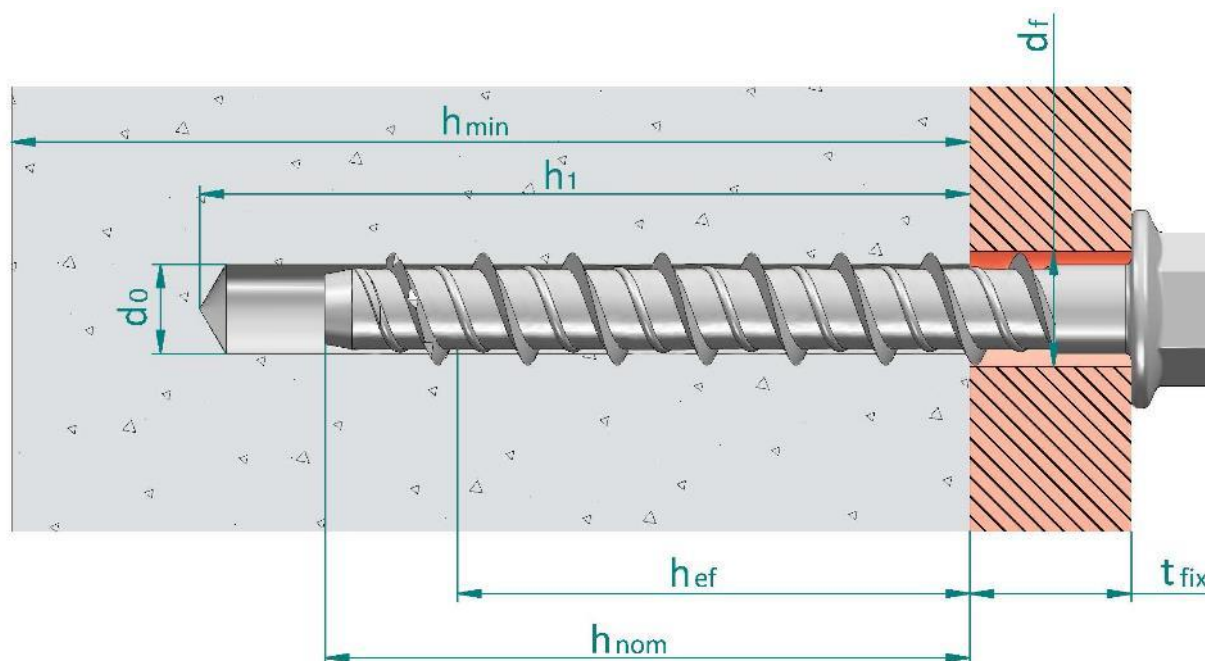

- d_o : Nominal diameter of drill bit
- d_f : Fixture clearance hole diameter
- h_{ef} : Effective anchorage depth
- h_1 : Depth of drilled hole
- h_{nom} : Overall fastener embedment depth in the concrete
- h_{min} : Minimum thickness of concrete member
- t_{fix} : Fixture thickness

2.2. SEISMIC LOAD ASSESSMENT

Family	Code	Size (Letter)	Assessed	C1	C2	Family	Code	Size	Assessed	C1	C2
[--]	[--]	[--]	ETA	[--]	[--]	[--]	[--]	[--]	ETA	[--]	[--]
THE	THE05040	Ø5 x 40 (A)	✓*	--	--	TFE	TFE05040	Ø5 x 40 (A)	✓*	--	--
	THE05050	Ø5 x 50 (A)	✓*	--	--		TFE05050	Ø5 x 50 (A)	✓*	--	--
	THE05060	Ø5 x 60 (B)	✓*	--	--		TFE05060	Ø5 x 60 (B)	✓*	--	--
	THE05080	Ø5 x 80 (D)	✓*	--	--		TFE05080	Ø5 x 80 (D)	✓*	--	--
	THE05100	Ø5 x 100 (E)	✓*	--	--		TFE05100	Ø5 x 100 (E)	✓*	--	--
	THE06040	Ø6 x 40	✓	--	--		TFE06040	Ø6 x 40	✓	--	--
	THE06050	Ø6 x 50	✓	✓	--		TFE06050	Ø6 x 50	✓	✓	--
	THE06060	Ø6 x 60	✓	✓	--		TFE06060	Ø6 x 60	✓	✓	--
	THE06070	Ø6 x 70	✓	✓	--		TFE06070	Ø6 x 70	✓	✓	--
	THE06080	Ø6 x 80	✓	✓	--		TFE06080	Ø6 x 80	✓	✓	--
	THE06100	Ø6 x 100	✓	✓	--		TFE06100	Ø6 x 100	✓	✓	--
	THE06120	Ø6 x 120	✓	✓	--		TFE06120	Ø6 x 120	✓	✓	--
	THE08055	Ø8 x 55	✓	✓	✓		TFE08055	Ø8 x 55	✓	✓	✓
	THE08060	Ø8 x 60	✓	✓	✓		TFE08060	Ø8 x 60	✓	✓	✓
	THE08070	Ø8 x 70	✓	✓	✓		TFE08070	Ø8 x 70	✓	✓	✓
	THE08080	Ø8 x 80	✓	✓	✓		TFE08080	Ø8 x 80	✓	✓	✓
	THE08090	Ø8 x 90	✓	✓	✓		TFE08090	Ø8 x 90	✓	✓	✓
	THE08100	Ø8 x 100	✓	✓	✓		TFE08100	Ø8 x 100	✓	✓	✓
	THE08110	Ø8 x 110	✓	✓	✓		TFE08110	Ø8 x 110	✓	✓	✓
	THE08120	Ø8 x 120	✓	✓	✓		TFE08120	Ø8 x 120	✓	✓	✓
	THE08140	Ø8 x 140	✓	✓	✓		TFE08140	Ø8 x 140	✓	✓	✓
	THE10060	Ø10 x 60	✓	--	--		TFE10060	Ø10 x 60	✓	--	--
	THE10070	Ø10 x 70	✓	--	--		TFE10070	Ø10 x 70	✓	--	--
	THE10080	Ø10 x 80	✓	--	--		TFE10080	Ø10 x 80	✓	--	--
	THE10090	Ø10 x 90	✓	✓	✓		TFE10090	Ø10 x 90	✓	✓	✓
	THE10100	Ø10 x 100	✓	✓	✓		TFE10100	Ø10 x 100	✓	✓	✓
	THE10120	Ø10 x 120	✓	✓	✓		TFE10120	Ø10 x 120	✓	✓	✓
	THE10140	Ø10 x 140	✓	✓	✓		TFE10140	Ø10 x 140	✓	✓	✓
	THE12080	Ø12 x 80	✓	--	--		TFE12080	Ø12 x 80	✓	--	--
	THE12090	Ø12 x 90	✓	--	--		TFE12090	Ø12 x 90	✓	--	--
	THE12110	Ø12 x 110	✓	✓	✓		TFE12110	Ø12 x 110	✓	✓	✓
	THE12130	Ø12 x 130	✓	✓	✓		TFE12130	Ø12 x 130	✓	✓	✓
	THE12150	Ø12 x 150	✓	✓	✓		TFE12150	Ø12 x 150	✓	✓	✓
	THE14080	Ø14 x 80	✓	--	--		TFE14080	Ø14 x 80	✓	--	--
	THE14100	Ø14 x 100	✓	--	--		TFE14100	Ø14 x 100	✓	--	--
	THE14120	Ø14 x 120	✓	✓	✓		TFE14120	Ø14 x 120	✓	✓	✓
	THE14130	Ø14 x 130	✓	✓	✓		TFE14130	Ø14 x 130	✓	✓	✓
	THE14140	Ø14 x 140	✓	✓	✓		TFE14140	Ø14 x 140	✓	✓	✓
	THE14160	Ø14 x 160	✓	✓	✓		TFE14160	Ø14 x 160	✓	✓	✓
	THE16100	Ø16 x 100	✓	--	--		TFE16100	Ø16 x 100	✓	--	--
THE16150	Ø16 x 100	✓	--	--	TFE16150	Ø16 x 100	✓	--	--		
THE18100	Ø18 x 100	✓	--	--	TFE18100	Ø18 x 100	✓	--	--		
THE18130	Ø18 x 130	✓	--	--	TFE18130	Ø18 x 130	✓	--	--		
THE18160	Ø18 x 160	✓	✓	✓	TFE18160	Ø18 x 160	✓	✓	✓		
THE18180	Ø18 x 180	✓	✓	✓	TFE18180	Ø18 x 180	✓	✓	✓		
THE18200	Ø18 x 200	✓	✓	✓	TFE18200	Ø18 x 200	✓	✓	✓		
TFF	TFF06035	Ø6 x 35 (M8-M10)	✓	--	--	THT	THT06040	Ø6 x 40	✓	--	--
	TFF06055	Ø6 x 55 (M8-M10)	✓	✓	--		THT06050	Ø6 x 50	✓	✓	--
TFM	TFM06035	Ø6 x 35 (M8)	✓	--	--		THT06060	Ø6 x 60	✓	✓	--
	TFM06055	Ø6 x 55 (M10)	✓	✓	--						

Family	Code	Size (Letter)	Assessed	C1	C2	Family	Code	Size	Assessed	C1	C2	
[--]	[--]	[--]	ETA	[--]	[--]	[--]	[--]	[--]	ETA	[--]	[--]	
THA	THA05040	Ø5 x 40 (A)	✓*	--	--	TFS	TFS06100	Ø6 x 100 (M8)	✓	✓	--	
	THA05060	Ø5 x 60 (B)	✓*	--	--		TFS06120	Ø6 x 120 (M8)	✓	✓	--	
	THA05080	Ø5 x 80 (D)	✓*	--	--		TFS08110	Ø8 x 110 (M10)	✓	✓	✓	
	THA05100	Ø5 x 100 (E)	✓*	--	--		TFS08130	Ø8 x 130 (M10)	✓	✓	✓	
	THA06045	Ø6 x 45	✓	--	--		TFS10120	Ø10 x 120 (M12)	✓	--	--	
	THA06050	Ø6 x 50	✓	✓	--		TFS10140	Ø10 x 140 (M12)	✓	--	--	
	THA06060	Ø6 x 60	✓	✓	--	TFN	TFN14080	Ø14 x 80	--	--	--	
	THA06080	Ø6 x 80	✓	✓	--	THP	THP05040	Ø5 x 40	✓*	--	--	
	THA06100	Ø6 x 120	✓	✓	--		THP05060	Ø5 x 60	✓*	--	--	
	THA06120	Ø6 x 120	✓	✓	--		THP06040	Ø6 x 40	✓	--	--	
	THA06140	Ø6 x 140	✓	✓	--		THP06050	Ø6 x 50	✓	✓	--	
	THA08060	Ø8 x 60	✓	✓	✓		THP06060	Ø6 x 60	✓	✓	--	
	THA08080	Ø8 x 80	✓	✓	✓		THP06080	Ø6 x 80	✓	✓	--	
	THA08100	Ø8 x 100	✓	✓	✓		THP06100	Ø6 x 100	✓	✓	--	
	THA08120	Ø8 x 120	✓	✓	✓		THP08060	Ø8 x 60	✓	✓	✓	
	THA10100	Ø10 x 100	✓	✓	✓		THP08080	Ø8 x 80	✓	✓	✓	
	THA10120	Ø10 x 120	✓	✓	✓							

3. INSTALLATION PARAMETERS

General Installation parameters											Standard Installation depth ($h_{ef, std}$)								Reduced Installation depth ($h_{ef, red}$)									
Family	Code	Size (Letter)	Assessed	Drill bit diameter	Fixture clearance hole	Spanner	Maximum torque	Minimum allowable spacing	Minimum allowable edge distance	Minimum concrete thickness	Depth of drill hole	Installation depth	Effective anchorage depth	Thickness of fixture	Critical spacing (concrete cone)	Critical edge distance (cone)	Critical spacing (splitting)	Critical edge distance (splitting)	Minimum concrete thickness	Depth of drill hole	Installation depth	Effective anchorage depth	Thickness of fixture	Critical spacing (concrete cone)	Critical edge distance (cone)	Critical spacing (splitting)	Critical edge distance (splitting)	
[--]	[--]	[--]	ETA	d_0 [mm]	d_f [mm]	SW/Tx [--]	T_{inst} [Nm]	S_{min} [mm]	C_{min} [mm]	h_{min} [mm]	h_1 [mm]	h_{nom} [mm]	h_{ef} [mm]	t_{fix} [mm]	$S_{cr,N}$ [mm]	$C_{cr,N}$ [mm]	$S_{cr,sp}$ [mm]	$C_{cr,sp}$ [mm]	h_{min} [mm]	h_1 [mm]	h_{nom} [mm]	h_{ef} [mm]	t_{fix} [mm]	$S_{cr,N}$ [mm]	$C_{cr,N}$ [mm]	$S_{cr,sp}$ [mm]	$C_{cr,sp}$ [mm]	
THE	THE05040	Ø5 x 40(A)	✓*	5	8	SW 8	5	35	35	--	--	--	--	--	--	--	--	--	80	45	35	26,5	5	80	40	80	40	
	THE05050	Ø5 x 50(A)	✓*			SW 8				5																		
	THE05060	Ø5 x 60(B)	✓*			SW 8				15																		
	THE05080	Ø5 x 80(D)	✓*			SW 8				35																		
	THE05100	Ø5 x 100(E)	✓*			SW 8				55																		
	THE06040	Ø6 x 40	✓	6	9	SW 10	10	35	35	--	--	--	--	--	--	--	--	--	100	45	35	26,0	5	100	39	90	45	
	THE06050	Ø6 x 50	✓			SW 10				15																		
	THE06060	Ø6 x 60	✓			SW 10				25																		
	THE06070	Ø6 x 70	✓			SW 10				35																		
	THE06080	Ø6 x 80	✓			SW 10				45																		
	THE06100	Ø6 x 100	✓	SW 10	65																							
	THE06120	Ø6 x 120	✓	SW 10	85																							
	THE08055	Ø8 x 55	✓	8	12	SW 13	20	35	35	--	--	--	--	--	--	--	--	--	--	100	60	50	37,5	5	100	57	130	65
	THE08060	Ø8 x 60	✓			SW 13				10																		
	THE08070	Ø8 x 70	✓			SW 13				20																		
	THE08080	Ø8 x 80	✓			SW 13				30																		
	THE08090	Ø8 x 90	✓			SW 13				40																		
	THE08100	Ø8 x 100	✓			SW 13				50																		
	THE08110	Ø8 x 110	✓			SW 13				60																		
	THE08120	Ø8 x 120	✓			SW 13				70																		
	THE08140	Ø8 x 140	✓			SW 13				90																		
THE10060	Ø10 x 60	✓	10			14				SW 15	30	50	40	--	--	--	--	--	--									
THE10070	Ø10 x 70	✓		SW 15	15																							
THE10080	Ø10 x 80	✓		SW 15	25																							
THE10090	Ø10 x 90	✓		SW 15	35																							
THE10100	Ø10 x 100	✓		SW 15	45																							
THE10120	Ø10 x 120	✓		SW 15	65																							
THE10140	Ø10 x 140	✓		SW 15	85																							
THE10140	Ø10 x 140	✓		SW 15	55																							

*Ø5 Assessed only for use in concrete and in precast prestressed hollow core slabs for redundant non-structural systems

General Installation parameters										Standard Installation depth ($h_{ef, std}$)								Reduced Installation depth ($h_{ef, red}$)										
Family	Code	Size (Letter)	Assessed	Drill bit diameter	Fixture clearance hole	Spanner	Maximum torque	Minimum allowable spacing	Minimum allowable edge distance	Minimum concrete thickness	Depth of drill hole	Installation depth	Effective anchorage depth	Thickness of fixture	Critical spacing (concrete cone)	Critical edge distance (cone)	Critical spacing (splitting)	Critical edge distance (splitting)	Minimum concrete thickness	Depth of drill hole	Installation depth	Effective anchorage depth	Thickness of fixture	Critical spacing (concrete cone)	Critical edge distance (cone)	Critical spacing (splitting)	Critical edge distance (splitting)	
[--]	[--]	[--]	ETA	d_0	d_f	SW/Tx	T_{inst}	S_{min}	C_{min}	h_{min}	h_1	h_{nom}	h_{ef}	t_{fix}	$S_{cr,N}$	$C_{cr,N}$	$S_{cr,sp}$	$C_{cr,sp}$	h_{min}	h_1	h_{nom}	h_{ef}	t_{fix}	$S_{cr,N}$	$C_{cr,N}$	$S_{cr,sp}$	$C_{cr,sp}$	
				[mm]	[mm]	[--]	[Nm]	[mm]	[mm]	[mm]	[mm]	[mm]	[mm]	[mm]	[mm]	[mm]	[mm]	[mm]	[mm]	[mm]	[mm]	[mm]	[mm]	[mm]	[mm]	[mm]	[mm]	[mm]
THE	THE12080	Ø12 x 80	✓	12	16	SW 18	50	75	45	--	--	--	--	--	--	--	--	--	120	90	75	58,0	5	174	87	190	95	
	THE12090	Ø12 x 90	✓			SW 18				--	--	--	--	--	15													
	THE12110	Ø12 x 110	✓			SW 18				5	251	126	220	110	35													
	THE12130	Ø12 x 130	✓			SW 18				25	251	126	220	110	55													
	THE12150	Ø12 x 150	✓			SW 18				45	251	126	220	110	75													
	THE14080	Ø14 x 80	✓	14	18	SW 21	70	80	50	--	--	--	--	--	--	--	--	--	120	90	75	58,0	5	174	87	190	95	
	THE14100	Ø14 x 100	✓			SW 21				--	--	--	--	--	25													
	THE14120	Ø14 x 120	✓			SW 21				5	276	138	230	115	45													
	THE14130	Ø14 x 130	✓			SW 21				15	276	138	230	115	55													
	THE14140	Ø14 x 140	✓			SW 21				25	276	138	230	115	65													
	THE14160	Ø14 x 160	✓	SW 21	45	276	138	230	115	85																		
	THE16100	Ø16 x 100	✓	16	20	SW24	80	80	50	--	--	--	--	--	--	--	--	--	115	100	80	58	20	174	87	180	90	
	THE16150	Ø16 x 150	✓			SW24				185	120	120	92	30	276	138	280	140					70					
	THE18100	Ø18 x 100	✓	18	22	SW 24	90	90	55	--	--	--	--	--	--	--	--	--	140	110	90	69,5	10	209	105	230	115	
	THE18130	Ø18 x 130	✓			SW 24				--	--	--	--	--	40													
	THE18160	Ø18 x 160	✓			SW 24				20	336	168	350	175	70													
THE18180	Ø18 x 180	✓	SW 24			40				336	168	350	175	90														
THE18200	Ø18 x 200	✓	SW 24			60				336	168	350	175	110														

General Installation parameters										Standard Installation depth ($h_{ef, std}$)								Reduced Installation depth ($h_{ef, red}$)										
Family	Code	Size (Letter)	Assessed	Drill bit diameter	Fixture clearance hole	Spanner	Maximum torque	Minimum allowable spacing	Minimum allowable edge distance	Minimum concrete thickness	Depth of drill hole	Installation depth	Effective anchorage depth	Thickness of fixture	Critical spacing (concrete cone)	Critical edge distance (cone)	Critical spacing (splitting)	Critical edge distance (splitting)	Minimum concrete thickness	Depth of drill hole	Installation depth	Effective anchorage depth	Thickness of fixture	Critical spacing (concrete cone)	Critical edge distance (cone)	Critical spacing (splitting)	Critical edge distance (splitting)	
[--]	[--]	[--]	ETA	d_0	d_f	SW/Tx	T_{inst}	S_{min}	C_{min}	h_{min}	h_1	h_{nom}	h_{ef}	t_{fix}	$S_{cr,N}$	$C_{cr,N}$	$S_{cr,sp}$	$C_{cr,sp}$	h_{min}	h_1	h_{nom}	h_{ef}	t_{fix}	$S_{cr,N}$	$C_{cr,N}$	$S_{cr,sp}$	$C_{cr,sp}$	
				[mm]	[mm]	[--]	[Nm]	[mm]	[mm]	[mm]	[mm]	[mm]	[mm]	[mm]	[mm]	[mm]	[mm]	[mm]	[mm]	[mm]	[mm]	[mm]	[mm]	[mm]	[mm]	[mm]	[mm]	[mm]
TFE	TFE05040	Ø5 x 40(A)	✓*	5	8	SW 8	5	35	35	--	--	--	--	--	--	--	--	--	80	45	35	26,5	5	80	40	80	40	
	TFE05050	Ø5 x 50(A)	✓*			15																						
	TFE05060	Ø5 x 60(B)	✓*			15																						
	TFE05080	Ø5 x 80(D)	✓*			35																						
	TFE05100	Ø5 x 100(E)	✓*			55																						
	TFE06040	Ø6 x 40	✓	6	9	SW 10	10	35	35	--	--	--	--	--	--	--	--	--	100	45	35	26,0	5	78	39	90	45	
	TFE06050	Ø6 x 50	✓			15																						
	TFE06060	Ø6 x 60	✓			25																						
	TFE06070	Ø6 x 70	✓			35																						
	TFE06080	Ø6 x 80	✓			45																						
	TFE06100	Ø6 x 100	✓	65																								
	TFE06120	Ø6 x 120	✓	85																								
	TFE08055	Ø8 x 55	✓	8	12	SW 13	20	35	35	--	--	--	--	--	--	--	--	--	100	60	50	37,5	5	113	57	130	65	
	TFE08060	Ø8 x 60	✓			10																						
	TFE08070	Ø8 x 70	✓			20																						
	TFE08080	Ø8 x 80	✓			15																						
	TFE08090	Ø8 x 90	✓			25																						
	TFE08100	Ø8 x 100	✓			35																						
	TFE08110	Ø8 x 110	✓			45																						
	TFE08120	Ø8 x 120	✓			55																						
	TFE08140	Ø8 x 140	✓			75																						
	TFE10060	Ø10 x 60	✓	10	14	SW 15	30	50	40	--	--	--	--	--	--	--	--	--	100	65	55	41,5	5	125	63	140	70	
	TFE10070	Ø10 x 70	✓			15																						
	TFE10080	Ø10 x 80	✓			25																						
	TFE10090	Ø10 x 90	✓			35																						
	TFE10100	Ø10 x 100	✓			45																						
	TFE10120	Ø10 x 120	✓			65																						
	TFE10140	Ø10 x 140	✓			85																						

*Ø5 Assessed only for use in concrete and in precast prestressed hollow core slabs for redundant non-structural systems

General Installation parameters										Standard Installation depth ($h_{ef, std}$)								Reduced Installation depth ($h_{ef, red}$)										
Family	Code	Size (Letter)	Assessed	Drill bit diameter	Fixture clearance hole	Spanner	Maximum torque	Minimum allowable spacing	Minimum allowable edge distance	Minimum concrete thickness	Depth of drill hole	Installation depth	Effective anchorage depth	Thickness of fixture	Critical spacing (concrete cone)	Critical edge distance (cone)	Critical spacing (splitting)	Critical edge distance (splitting)	Minimum concrete thickness	Depth of drill hole	Installation depth	Effective anchorage depth	Thickness of fixture	Critical spacing (concrete cone)	Critical edge distance (cone)	Critical spacing (splitting)	Critical edge distance (splitting)	
[--]	[--]	[--]	ETA	d_0	d_f	SW/Tx	T_{inst}	S_{min}	C_{min}	h_{min}	h_1	h_{nom}	h_{ef}	t_{fix}	$S_{cr,N}$	$C_{cr,N}$	$S_{cr,sp}$	$C_{cr,sp}$	h_{min}	h_1	h_{nom}	h_{ef}	t_{fix}	$S_{cr,N}$	$C_{cr,N}$	$S_{cr,sp}$	$C_{cr,sp}$	
				[mm]	[mm]	[--]	[Nm]	[mm]	[mm]	[mm]	[mm]	[mm]	[mm]	[mm]	[mm]	[mm]	[mm]	[mm]	[mm]	[mm]	[mm]	[mm]	[mm]	[mm]	[mm]	[mm]	[mm]	[mm]
TFE	TFE12080	Ø12 x 80	✓	12	16	SW 18	50	75	45	--	--	--	--	--	--	--	--	--	120	90	75	58,0	5	174	87	190	95	
	TFE12090	Ø12 x 90	✓			SW 18				--	--	--	--	--	15													
	TFE12110	Ø12 x 110	✓			SW 18				5	251	126	220	110	35													
	TFE12130	Ø12 x 130	✓			SW 18				25	251	126	220	110	55													
	TFE12150	Ø12 x 150	✓			SW 18				45	251	126	220	110	75													
	TFE14080	Ø14 x 80	✓	14	18	SW 21	70	80	50	--	--	--	--	--	--	--	--	--	120	90	75	58,0	5	174	87	190	95	
	TFE14100	Ø14 x 100	✓			SW 21				--	--	--	--	--	25													
	TFE14120	Ø14 x 120	✓			SW 21				5	276	138	230	115	45													
	TFE14130	Ø14 x 130	✓			SW 21				15	276	138	230	115	55													
	TFE14140	Ø14 x 140	✓			SW 21				25	276	138	230	115	65													
	TFE14160	Ø14 x 160	✓	SW 21	45	276	138	230	115	85																		
	TFE16100	Ø16 x 100	✓	16	20	SW24	80	80	50	--	--	--	--	--	--	--	--	--	115	100	80	58	20	174	87	180	90	
	TFE16150	Ø16 x 150	✓			SW24				185	120	120	92	30	276	138	280	140					70					
	TFE18100	Ø18 x 100	✓	18	22	SW 24	90	90	55	--	--	--	--	--	--	--	--	--	--	140	110	90	69,5	10	209	105	230	115
TFE18130	Ø18 x 130	✓	SW 24			--				--	--	--	--	40														
TFE18160	Ø18 x 160	✓	SW 24			20				336	168	350	175	70														
TFE18180	Ø18 x 180	✓	SW 24			40				336	168	350	175	90														
TFE18200	Ø18 x 200	✓	SW 24			60				336	168	350	175	110														
TFN	TFN14080	Ø14 x 80	✓	14	18	SW 24	70	80	50	--	--	--	--	--	--	--	--	--	120	90	75	58,0	5	174	87	190	95	

General Installation parameters										Standard Installation depth ($h_{ef, std}$)								Reduced Installation depth ($h_{ef, red}$)										
Family	Code	Size (Letter)	Assessed	Drill bit diameter	Fixture clearance hole	Spanner	Maximum torque	Minimum allowable spacing	Minimum allowable edge	Minimum concrete thickness	Depth of drill hole	Installation depth	Effective anchorage depth	Thickness of fixture	Critical spacing (concrete cone)	Critical edge distance (cone)	Critical spacing (splitting)	Critical edge distance (splitting)	Minimum concrete thickness	Depth of drill hole	Installation depth	Effective anchorage depth	Thickness of fixture	Critical spacing (concrete cone)	Critical edge distance (cone)	Critical spacing (splitting)	Critical edge distance (splitting)	
																												d_0
[--]	[--]	[--]	ETA	[mm]	[mm]	[--]	[Nm]	[mm]	[mm]	[mm]	[mm]	[mm]	[mm]	[mm]	[mm]	[mm]	[mm]	[mm]	[mm]	[mm]	[mm]	[mm]	[mm]	[mm]	[mm]	[mm]	[mm]	
THA	THA05040	Ø5 x 40(A)	✓*	5	8	TX25	5	35	35	80	55	45	35,0	15	105	53	105	53	80	45	35	26,5	5	80	40	80	40	
	THA05060	Ø5 x 60(B)	✓*			TX25																						25
	THA05080	Ø5 x 80(D)	✓*			TX25																						45
	THA05100	Ø5 x 100(E)	✓*			TX25																						65
	THA06045	Ø6 x 45	✓	6	9	TX30	10	35	35	100	65	55	43,0	5	129	65	170	85	100	45	35	26,0	10	78	39	90	45	
	THA06050	Ø6 x 50	✓			TX30																						15
	THA06060	Ø6 x 60	✓			TX30																						25
	THA06080	Ø6 x 80	✓			TX30																						45
	THA06100	Ø6 x 100	✓			TX30																						65
	THA06120	Ø6 x 120	✓			TX30																						85
	THA06140	Ø6 x 140	✓	TX30	105																							
	THA08060	Ø8 x 60	✓	8	12	TX45	20	35	35	100	75	65	50,5	15	152	76	200	100	100	60	50	37,5	10	113	57	130	65	
	THA08080	Ø8 x 80	✓			TX45																						30
	THA08100	Ø8 x 100	✓			TX45																						50
THA08120	Ø8 x 120	✓	TX45			70																						
THA10100	Ø10 x 100	✓	10	14	TX50	30	50	40	135	95	85	67,0	15	201	101	210	105	100	65	55	41,5	45	125	63	140	70		
THA10120	Ø10 x 120	✓			TX50																						65	
THT	THT06040	Ø6 x 40	✓	6	9	TX30	10	35	35	100	65	55	43,0	5	129	65	170	85	100	45	35	26,0	5	78	39	90	45	
	THT06050	Ø6 x 50	✓			TX30																						15
	THT06060	Ø6 x 60	✓			TX30																						25
THP	THP05040	Ø5 x 40(A)	✓*	5	8	TX30	5	35	35	80	55	45	35,0	15	105	53	105	53	80	45	35	26,5	5	80	40	80	40	
	THP05060	Ø5 x 60(B)	✓*			TX30																						25
	THP06040	Ø6 x 40	✓	6	9	TX40	10	35	35	100	65	55	43,0	5	129	65	170	85	100	45	35	26,0	15	78	39	90	45	
	THP06050	Ø6 x 50	✓			TX40																						25
	THP06060	Ø6 x 60	✓			TX40																						45
	THP06080	Ø6 x 80	✓			TX40																						65
	THP06100	Ø6 x 100	✓	TX40	85																							
	THP08060	Ø8 x 60	✓	8	12	TX45	20	35	35	100	75	65	50,5	15	152	76	200	100	100	60	50	37,5	10	113	57	130	65	
THP08080	Ø8 x 80	✓	TX45			30																						

*Ø5 Assessed only for use in concrete and in precast prestressed hollow core slabs for redundant non-structural systems

General Installation parameters										Standard Installation depth ($h_{ef, std}$)								Reduced Installation depth ($h_{ef, red}$)									
Family	Code	Size (Letter)	Assessed	Drill bit diameter	Fixture clearance hole	Spanner	Maximum torque	Minimum allowable spacing	Minimum allowable edge	Minimum concrete thickness	Depth of drill hole	Installation depth	Effective anchorage depth	Thickness of fixture	Critical spacing (concrete cone)	Critical edge distance (cone)	Critical spacing (splitting)	Critical edge distance (splitting)	Minimum concrete thickness	Depth of drill hole	Installation depth	Effective anchorage depth	Thickness of fixture	Critical spacing (concrete cone)	Critical edge distance (cone)	Critical spacing (splitting)	Critical edge distance (splitting)
				d_0 [mm]	d_f [mm]																						
[--]	[--]	[--]	ETA	[mm]	[mm]	[--]	[Nm]	[mm]	[mm]	[mm]	[mm]	[mm]	[mm]	[mm]	[mm]	[mm]	[mm]	[mm]	[mm]	[mm]	[mm]	[mm]	[mm]	[mm]	[mm]	[mm]	[mm]
TFF	TFF06035	Ø6 x 35 (M8-M10)	✓	6	--	SW 13	10	35	35	--	--	--	--	--	--	--	--	--	100	45	35	26,0	--	78	39	90	45
	TFF06055	Ø6 x 55 (M8-M10)	✓			SW 13				100	65	55	43,0	--	129	65	170	85	--	--	--	--	--	--	--	--	--
TFM	TFM06035	Ø6 x 35 (M8)	✓	6	--	SW 13	10	35	35	--	--	--	--	--	--	--	--	--	100	65	55	26,0	--	78	39	90	45
	TFM06055	Ø6 x 55 (M10)	✓			SW 13				100	65	55	43,0	--	129	65	170	85	--	--	--	--	--	--	--	--	--
TFS	TFS06100	Ø6 x 100 (M8)	✓	6	9	SW 5	10	35	35	100	65	55	43,0	31	129	65	170	85	100	45	35	26,0	51	78	39	90	45
	TFS06120	Ø6 x 120 (M8)	✓			SW 5								51									71				
	TFS08110	Ø8 x 110 (M10)	✓	8	12	SW 7	20	35	35	100	75	65	50,5	29	152	76	200	100	100	60	50	37,5	44	113	57	130	65
	TFS08130	Ø8 x 130 (M10)	✓			SW 7								44									64				
	TFS10120	Ø10 x 120 (M12)	✓	10	14	SW 8	30	50	40	120	85	75	58,5	26	176	88	190	95	100	65	55	41,5	46	125	63	140	70
	TFS10140	Ø10 x 140 (M12)	✓			SW 8								46									66				

4. INSTALLATION PROCEDURE

4.1. CONCRETE INSTALLATION

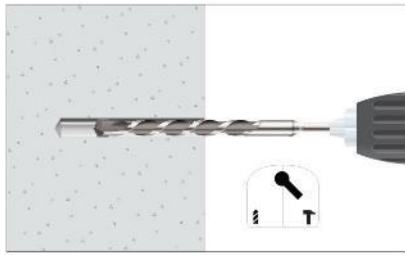

1. DRILLING

Check the concrete is well compacted and without significant porosity. Suitable for dry, wet and flooded holes. Use drill in hammer mode. Drill according to specified depths in previous tables.



2. BLOW AND CLEAN

Clean the hole from dust and concrete remains. Use blow pump and brush.

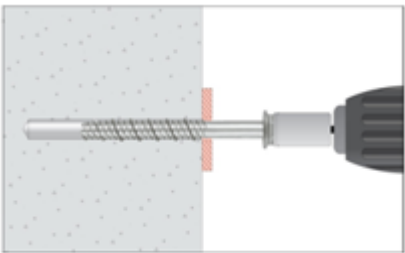

3. INSTALL

Select a powered impact wrench or a torque wrench that does not exceed the maximum torque indicated in previous tables. Attach an appropriate size hex socket to the wrench. Mount the screw anchor head in the socket.

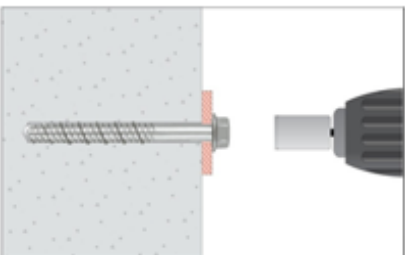

4. APPLY THE TORQUE

Drive the anchor with an impact driver or a torque wrench through the fixture and into the hole until the anchor head washer comes in contact with the fixture. The anchor must be snug after installation. Do not spin the hex socket off the anchor to disengage.

5. RESISTANCES

Resistances in concrete class C20/25 for an isolated anchor without spacing or concrete edge distance effects are indicated in the following table:

Values underlined and in italics show Steel failure, **bold** values concrete failure and other indicate pull out failure.
1 KN ≈ 100 kg

5.1 CHARACTERISTIC RESISTANCE (STRUCTURAL APPLICATION) [kN]

General Parameter				Non-cracked concrete				Cracked concrete				
Family	Code	Size	ETA Assessed	Tension N _{Rk, ucr}		Shear V _{Rk, ucr}		Tension N _{Rk, ucr}		Shear V _{Rk, ucr}		
				(h _{ef, std})	(h _{ef, red})	(h _{ef, std})	(h _{ef, red})	(h _{ef, std})	(h _{ef, red})	(h _{ef, std})	(h _{ef, red})	
THE	THE05040	Ø5 x 40	✓*	--	6,71	--	6,71	--	4,70	--	4,70	
	THE05050	Ø5 x 50	✓*	10,19	6,71	<u><i>8,19</i></u>	6,71	7,13	4,70	7,13	4,70	
	THE05060	Ø5 x 60	✓*									
	THE05080	Ø5 x 80	✓*									
	THE05100	Ø5 x 100	✓*									
	THE06040	Ø6 x 40	✓	--	5,00	--	<u><i>12,53</i></u>	--	4,57	--	9,36	
	THE06050	Ø6 x 50	✓	--		--						
	THE06060	Ø6 x 60	✓	13,87	5,00	<u><i>12,53</i></u>	<u><i>12,53</i></u>	9,71	4,57	11,17	9,36	
	THE06070	Ø6 x 70	✓									
	THE06080	Ø6 x 80	✓									
	THE06100	Ø6 x 100	✓									
	THE06120	Ø6 x 120	✓									
	THE08055	Ø8 x 55	✓	--	11,30	--	<u><i>19,57</i></u>	--	7,91	--	14,23	
	THE08060	Ø8 x 60	✓	--		--						
	THE08070	Ø8 x 70	✓	17,65	11,30	<u><i>19,57</i></u>	<u><i>19,57</i></u>	12,36	7,91	15,69	14,23	
	THE08080	Ø8 x 80	✓									
	THE08090	Ø8 x 90	✓									
	THE08100	Ø8 x 100	✓									
	THE08110	Ø8 x 110	✓									
	THE08120	Ø8 x 120	✓									
	THE08140	Ø8 x 140	✓	--	13,15	--	25,65	--	9,21	--	17,95	
	THE10060	Ø10 x 60	✓	--		--						
	THE10070	Ø10 x 70	✓	--	26,98	13,15	<u><i>27,40</i></u>	25,65	18,89	9,21	<u><i>27,40</i></u>	17,95
	THE10080	Ø10 x 80	✓									
	THE10090	Ø10 x 90	✓									
	THE10100	Ø10 x 100	✓									
	THE10120	Ø10 x 120	✓	37,54	21,73	<u><i>37,24</i></u>	<u><i>37,24</i></u>	26,27	15,21	<u><i>37,24</i></u>	35,44	
	THE10140	Ø10 x 140	✓									
	THE12080	Ø12 x 80	✓	--	21,73	--	<u><i>37,24</i></u>	--	15,21	--	35,44	
	THE12090	Ø12 x 90	✓	--		--						
	THE12110	Ø12 x 110	✓	37,54	21,73	<u><i>37,24</i></u>	<u><i>37,24</i></u>	26,27	15,21	<u><i>37,24</i></u>	35,44	
	THE12130	Ø12 x 130	✓									
THE12150	Ø12 x 150	✓										
THE14080	Ø14 x 80	✓	--	21,73	--	<u><i>52,72</i></u>	--	15,21	--	38,79		
THE14100	Ø14 x 100	✓	--		--							
THE14120	Ø14 x 120	✓	43,41	21,73	<u><i>52,72</i></u>	<u><i>52,72</i></u>	30,39	15,21	<u><i>52,72</i></u>	38,79		
THE14130	Ø14 x 130	✓										
THE14140	Ø14 x 140	✓										
THE14160	Ø14 x 160	✓										
TFE16100	Ø16 x 100	✓	--	--	--	--	30,39	15,21	<u><i>52,72</i></u>	32,55		
TFE16150	Ø16 x 150	✓	43,41	21,73	<u><i>57,97</i></u>	46,50						
THE18100	Ø18 x 100	✓	--	28,50	--	75,82	--	19,95	--	53,07		
THE18130	Ø18 x 130	✓	--		--							
THE18160	Ø18 x 160	✓	58,31	28,50	<u><i>80,78</i></u>	75,82	40,82	19,95	<u><i>80,78</i></u>	53,07		
THE18180	Ø18 x 180	✓										
THE18200	Ø18 x 200	✓										

*Ø5 Assessed only for use in concrete and in precast prestressed hollow core slabs for redundant non-structural systems

General Parameter				Non-cracked concrete				Cracked concrete			
Family	Code	Size	ETA Assessed	Tension $N_{Rk, ucr}$		Shear $V_{Rk, ucr}$		Tension $N_{Rk, ucr}$		Shear $V_{Rk, ucr}$	
				($h_{ef, std}$)	($h_{ef, red}$)	($h_{ef, std}$)	($h_{ef, red}$)	($h_{ef, std}$)	($h_{ef, red}$)	($h_{ef, std}$)	($h_{ef, red}$)
TFE	TFE05040	Ø5 x 40	✓*	--	6,71	--	6,71	--	4,70	--	4,70
	TFE05050	Ø5 x 50	✓*	10,19	6,71	<u>8,19</u>	6,71	7,13	4,70	7,13	4,70
	TFE05060	Ø5 x 60	✓*								
	TFE05080	Ø5 x 80	✓*								
	TFE05100	Ø5 x 100	✓*								
	TFE06040	Ø6 x 40	✓	--	5,00	--	<u>12,53</u>	--	4,57	--	9,36
	TFE06050	Ø6 x 50	✓	--		--		--			
	TFE06060	Ø6 x 60	✓	13,87	5,00	<u>12,53</u>	<u>12,53</u>	9,71	4,57	11,17	9,36
	TFE06070	Ø6 x 70	✓								
	TFE06080	Ø6 x 80	✓								
	TFE06100	Ø6 x 100	✓								
	TFE06120	Ø6 x 120	✓								
	TFE08055	Ø8 x 55	✓								
	TFE08060	Ø8 x 60	✓	--	--	--					
	TFE08070	Ø8 x 70	✓	17,65	11,30	<u>19,57</u>	<u>19,57</u>	12,36	7,91	15,69	14,23
	TFE08080	Ø8 x 80	✓								
	TFE08090	Ø8 x 90	✓								
	TFE08100	Ø8 x 100	✓								
	TFE08110	Ø8 x 110	✓								
	TFE08120	Ø8 x 120	✓								
	TFE08140	Ø8 x 140	✓	--	13,15	--	25,65	--	9,21	--	17,95
	TFE10060	Ø10 x 60	✓	--		--		--		--	
	TFE10070	Ø10 x 70	✓	--	13,15	--	25,65	--	9,21	--	17,95
	TFE10080	Ø10 x 80	✓	--		--		--		--	
	TFE10090	Ø10 x 90	✓	26,98	13,15	<u>27,40</u>	25,65	18,89	9,21	<u>27,40</u>	17,95
	TFE10100	Ø10 x 100	✓								
	TFE10120	Ø10 x 120	✓								
	TFE10140	Ø10 x 140	✓								
	TFE12080	Ø12 x 80	✓	--	21,73	--	<u>37,24</u>	--	15,21	--	35,44
	TFE12090	Ø12 x 90	✓	--		--		--			
	TFE12110	Ø12 x 110	✓	37,54	21,73	<u>37,24</u>	<u>37,24</u>	26,27	15,21	<u>37,24</u>	35,44
	TFE12130	Ø12 x 130	✓								
TFE12150	Ø12 x 150	✓									
TFE14080	Ø14 x 80	✓	--	21,73	--	<u>52,72</u>	--	15,21	--	38,79	
TFE14100	Ø14 x 100	✓	--		--		--				
TFE14120	Ø14 x 120	✓	43,41	21,73	<u>52,72</u>	<u>52,72</u>	30,39	15,21	<u>52,72</u>	38,79	
TFE14130	Ø14 x 130	✓									
TFE14140	Ø14 x 140	✓									
TFE14160	Ø14 x 160	✓									
TFE16100	Ø16 x 100	✓	--	--	--	--	30,39	15,21	<u>52,72</u>	32,55	
TFE16150	Ø16 x 150	✓	43,41	21,73	<u>57,97</u>	46,50					
TFE18100	Ø18 x 100	✓	--	28,50	--	75,82	--	19,95	--	53,07	
TFE18130	Ø18 x 130	✓	--		--		--				
TFE18160	Ø18 x 160	✓	58,31	28,50	<u>80,78</u>	75,82	40,82	19,95	<u>80,78</u>	53,07	
TFE18180	Ø18 x 180	✓									
TFE18200	Ø18 x 200	✓									
THA05040	Ø5 x 40	✓*									--
THA05060	Ø5 x 60	✓*	10,19	6,71	<u>8,19</u>	6,71	7,13	4,70	7,13	4,70	
THA05080	Ø5 x 80	✓*									
THA05100	Ø5 x 100	✓*									
THA06045	Ø6 x 45	✓	--	5,00	--	<u>12,53</u>	--	4,57	--	9,36	
THA06050	Ø6 x 50	✓	--		--		--				
THA06060	Ø6 x 60	✓	13,87	5,00	<u>12,53</u>	<u>12,53</u>	9,71	4,57	11,17	9,36	
THA06080	Ø6 x 80	✓									
THA06100	Ø6 x 100	✓									
THA06120	Ø6 x 120	✓									
THA06140	Ø6 x 140	✓	--	11,30	--	<u>19,57</u>	--	7,91	--	14,23	
THA08060	Ø8 x 60	✓	--		--		--				
THA08080	Ø8 x 80	✓	17,65	11,30	<u>19,57</u>	<u>19,57</u>	12,36	7,91	15,69	14,23	
THA08100	Ø8 x 100	✓									
THA08120	Ø8 x 120	✓									
THA10100	Ø10 x 100	✓									
THA10120	Ø10 x 120	✓	26,98	13,15	<u>27,40</u>	25,65	18,89	9,21	<u>27,40</u>	17,95	

*Ø5 Assessed only for use in concrete and in precast prestressed hollow core slabs for redundant non-structural systems

General Parameter				Non-cracked concrete				Cracked concrete			
Family	Code	Size	ETA Assessed	Tension $N_{Rk, ucr}$		Shear $V_{Rk, ucr}$		Tension $N_{Rk, ucr}$		Shear $V_{Rk, ucr}$	
				($h_{ef, std}$)	($h_{ef, red}$)	($h_{ef, std}$)	($h_{ef, red}$)	($h_{ef, std}$)	($h_{ef, red}$)	($h_{ef, std}$)	($h_{ef, red}$)
THT	THT06040	Ø6 x 40	✓	--	5,00	--	<u>12,53</u>	--	4,57	--	9,36
	THT06050	Ø6 x 50	✓	--	--	--	--	--	--	--	--
	THT06060	Ø6 x 60	✓	13,87	5,00	<u>12,53</u>	<u>12,53</u>	9,71	4,57	11,17	9,36
THP	THP05040	Ø5 x 40	✓*	--	6,71	--	6,71	--	4,70	--	4,70
	THP05060	Ø5 x 60	✓*	10,19	6,71	<u>8,19</u>	6,71	7,13	4,70	7,13	4,70
	THP06040	Ø6 x 40	✓	--	5,00	--	<u>12,53</u>	9,71	4,57	--	9,36
	THP06050	Ø6 x 50	✓	--	--	--	--	--	--	--	--
	THP06060	Ø6 x 60	✓	--	--	--	--	--	--	--	--
	THP06080	Ø6 x 80	✓	13,87	5,00	<u>12,53</u>	<u>12,53</u>	9,71	4,57	11,17	9,36
	THP06100	Ø6 x 100	✓	--	--	--	--	--	--	--	--
	THP08060	Ø8 x 60	✓	--	11,30	--	<u>19,57</u>	--	7,91	--	14,23
	THP08080	Ø8 x 80	✓	17,65	11,30	<u>19,57</u>	<u>19,57</u>	12,36	7,91	15,69	14,23
TFF	TFF06035	Ø6 x 35 (M8-M10)	✓	--	5,00	--	--	--	4,57	--	--
	TFF06055	Ø6 x 55 (M8-M10)	✓	13,87	--	--	--	9,71	--	--	--
TFM	TFM06035	Ø6 x 35 (M8)	✓	--	5,00	--	--	--	4,57	--	--
	TFM06055	Ø6 x 55 (M10)	✓	13,87	--	--	--	9,71	--	--	--
TFS	TFS06100	Ø6 x 100 (M8)	✓	13,87	5,00	<u>12,53</u>	<u>12,53</u>	9,71	4,57	11,17	9,36
	TFS06120	Ø6 x 120 (M8)	✓								
	TFS08110	Ø8 x 110 (M10)	✓	17,65	11,30	<u>19,57</u>	<u>19,57</u>	12,36	7,91	15,69	14,23
	TFS08130	Ø8 x 130 (M10)	✓								
	TFS10120	Ø10 x 120 (M12)	✓	22,01	13,15	<u>27,40</u>	25,65	15,41	9,21	20,34	17,95
	TFS10140	Ø10 x 140 (M12)	✓								
TFS10140	Ø10 x 140 (M12)	✓									

*Ø5 Assessed only for use in concrete and in precast prestressed hollow core slabs for redundant non-structural systems

5.2 DESIGN RESISTANCE (STRUCTURAL APPLICATION) [kN]

General Parameter				Non-cracked concrete				Cracked concrete			
Family	Code	Size	ETA Assessed	Tension $N_{Rk, ucr}$		Shear $V_{Rk, ucr}$		Tension $N_{Rk, ucr}$		Shear $V_{Rk, ucr}$	
				($h_{ef, std}$)	($h_{ef, red}$)	($h_{ef, std}$)	($h_{ef, red}$)	($h_{ef, std}$)	($h_{ef, red}$)	($h_{ef, std}$)	($h_{ef, red}$)
THE	THE05040	Ø5 x 40	✓*	--	4,47	--	4,47	--	3,13	--	3,13
	THE05050	Ø5 x 50	✓*	6,79	4,47	<u>5,46</u>	4,47	4,75	3,13	4,75	3,13
	THE05060	Ø5 x 60	✓*								
	THE05080	Ø5 x 80	✓*								
	THE05100	Ø5 x 100	✓*								
	THE06040	Ø6 x 40	✓	--	2,78	--	<u>8,35</u>	--	2,54	--	6,24
	THE06050	Ø6 x 50	✓	--		--		--			
	THE06060	Ø6 x 60	✓	9,25	2,78	<u>8,35</u>	<u>8,35</u>	6,47	2,54	7,44	6,24
	THE06070	Ø6 x 70	✓								
	THE06080	Ø6 x 80	✓								
	THE06100	Ø6 x 100	✓								
	THE06120	Ø6 x 120	✓								
	THE08055	Ø8 x 55	✓	--	6,28	--	<u>13,05</u>	--	4,39	--	9,49
	THE08060	Ø8 x 60	✓	--		--		--			
	THE08070	Ø8 x 70	✓	11,77	6,28	<u>13,05</u>	<u>13,05</u>	8,24	4,39	10,46	9,49
	THE08080	Ø8 x 80	✓								
	THE08090	Ø8 x 90	✓								
	THE08100	Ø8 x 100	✓								
	THE08110	Ø8 x 110	✓								
	THE08120	Ø8 x 120	✓								
	THE10060	Ø10 x 60	✓	--	8,77	--	17,10	--	6,14	--	11,97
	THE10070	Ø10 x 70	✓	--		--		--			
	THE10080	Ø10 x 80	✓	--		--		--			
	THE10090	Ø10 x 90	✓	17,99	8,77	<u>18,27</u>	17,10	12,59	6,14	<u>18,27</u>	11,97
	THE10100	Ø10 x 100	✓								
	THE10120	Ø10 x 120	✓								
	THE10140	Ø10 x 140	✓								
	THE12080	Ø12 x 80	✓	--	14,49	--	<u>24,83</u>	--	10,14	--	23,63
	THE12090	Ø12 x 90	✓	--		--		--			
	THE12110	Ø12 x 110	✓	25,02	14,49	<u>24,83</u>	<u>24,83</u>	17,52	10,14	<u>24,83</u>	23,63
	THE12130	Ø12 x 130	✓								
	THE12150	Ø12 x 150	✓								
THE14080	Ø14 x 80	✓	--	14,49	--	<u>35,15</u>	--	10,14	--	25,86	
THE14100	Ø14 x 100	✓	--		--		--				
THE14120	Ø14 x 120	✓	28,94	14,49	<u>35,15</u>	<u>35,15</u>	20,26	10,14	<u>35,15</u>	25,86	
THE14130	Ø14 x 130	✓									
THE14140	Ø14 x 140	✓									
THE14160	Ø14 x 160	✓									
THE16100	Ø16 x 100	✓	--	--	--	--	20,26	10,14	<u>38,65</u>	21,70	
THE16150	Ø16 x 150	✓	28,94	14,49	<u>38,65</u>	31,00					
THE18100	Ø18 x 100	✓	--	19,00	--	50,54	--	13,30	--	35,38	
THE18130	Ø18 x 130	✓	--		--		--				
THE18160	Ø18 x 160	✓	38,87	19,00	<u>53,85</u>	50,54	27,21	13,30	<u>53,85</u>	35,38	
THE18180	Ø18 x 180	✓									
THE18200	Ø18 x 200	✓									

*Ø5 Assessed only for use in concrete and in precast prestressed hollow core slabs for redundant non-structural systems

General Parameter				Non-cracked concrete				Cracked concrete			
Family	Code	Size	ETA Assessed	Tension $N_{RK, ucr}$		Shear $V_{RK, ucr}$		Tension $N_{RK, ucr}$		Shear $V_{RK, ucr}$	
				($h_{ef, std}$)	($h_{ef, red}$)	($h_{ef, std}$)	($h_{ef, red}$)	($h_{ef, std}$)	($h_{ef, red}$)	($h_{ef, std}$)	($h_{ef, red}$)
TFE	TFE05040	Ø5 x 40	✓*	--	4,47	--	4,47	--	3,13	--	3,13
	TFE05050	Ø5 x 50	✓*	6,79	4,47	<u>5,46</u>	4,47	4,75	3,13	4,75	3,13
	TFE05060	Ø5 x 60	✓*								
	TFE05080	Ø5 x 80	✓*								
	TFE05100	Ø5 x 100	✓*								
	TFE06040	Ø6 x 40	✓	--	2,78	--	<u>8,35</u>	--	2,54	--	6,24
	TFE06050	Ø6 x 50	✓								
	TFE06060	Ø6 x 60	✓	9,25	2,78	<u>8,35</u>	<u>8,35</u>	6,47	2,54	7,44	6,24
	TFE06070	Ø6 x 70	✓								
	TFE06080	Ø6 x 80	✓								
	TFE06100	Ø6 x 100	✓								
	TFE06120	Ø6 x 120	✓								
	TFE08055	Ø8 x 55	✓								
	TFE08060	Ø8 x 60	✓								
	TFE08070	Ø8 x 70	✓	11,77	6,28	<u>13,05</u>	<u>13,05</u>	8,24	4,39	10,46	9,49
	TFE08080	Ø8 x 80	✓								
	TFE08090	Ø8 x 90	✓								
	TFE08100	Ø8 x 100	✓								
	TFE08110	Ø8 x 110	✓								
	TFE08120	Ø8 x 120	✓								
	TFE08140	Ø8 x 140	✓	--	8,77	--	17,10	--	6,14	--	11,97
	TFE10060	Ø10 x 60	✓								
	TFE10070	Ø10 x 70	✓	--	8,77	--	17,10	--	6,14	--	11,97
	TFE10080	Ø10 x 80	✓								
	TFE10090	Ø10 x 90	✓	17,99	8,77	<u>18,27</u>	17,10	12,59	6,14	<u>18,27</u>	11,97
	TFE10100	Ø10 x 100	✓								
	TFE10120	Ø10 x 120	✓								
	TFE10140	Ø10 x 140	✓								
	TFE12080	Ø12 x 80	✓	--	14,49	--	<u>24,83</u>	--	10,14	--	23,63
	TFE12090	Ø12 x 90	✓								
	TFE12110	Ø12 x 110	✓	25,02	14,49	<u>24,83</u>	<u>24,83</u>	17,52	10,14	<u>24,83</u>	23,63
	TFE12130	Ø12 x 130	✓								
TFE12150	Ø12 x 150	✓									
TFE14080	Ø14 x 80	✓	--	14,49	--	<u>35,15</u>	--	10,14	--	25,86	
TFE14100	Ø14 x 100	✓									
TFE14120	Ø14 x 120	✓	28,94	14,49	<u>35,15</u>	<u>35,15</u>	20,26	10,14	<u>35,15</u>	25,86	
TFE14130	Ø14 x 130	✓									
TFE14140	Ø14 x 140	✓									
TFE14160	Ø14 x 160	✓									
TFE16100	Ø16 x 100	✓	--	--	--	--	20,26	10,14	<u>38,65</u>	21,70	
TFE16150	Ø16 x 150	✓									
TFE18100	Ø18 x 100	✓	--	19,00	--	50,54	--	13,30	--	35,38	
TFE18130	Ø18 x 130	✓									
TFE18160	Ø18 x 160	✓	38,87	19,00	<u>53,85</u>	50,54	27,21	13,30	<u>53,85</u>	35,38	
TFE18180	Ø18 x 180	✓									
TFE18200	Ø18 x 200	✓									
THA05040	Ø5 x 40	✓*									--
THA	THA05060	Ø5 x 60	✓*	6,79	4,47	<u>5,46</u>	4,47	4,75	3,13	4,75	3,13
	THA05080	Ø5 x 80	✓*								
	THA05100	Ø5 x 100	✓*								
	THA06045	Ø6 x 45	✓								
	THA06050	Ø6 x 50	✓	--	2,78	--	<u>8,35</u>	--	2,54	--	6,24
	THA06060	Ø6 x 60	✓								
	THA06080	Ø6 x 80	✓	9,25	2,78	<u>8,35</u>	<u>8,35</u>	6,47	2,54	7,44	6,24
	THA06100	Ø6 x 100	✓								
	THA06120	Ø6 x 120	✓								
	THA06140	Ø6 x 140	✓								
	THA08060	Ø8 x 60	✓	--	6,28	--	<u>13,05</u>	--	4,39	--	9,49
	THA08080	Ø8 x 80	✓								
	THA08100	Ø8 x 100	✓	11,77	6,28	<u>13,05</u>	<u>13,05</u>	8,24	4,39	10,46	9,49
	THA08120	Ø8 x 120	✓								
	THA10100	Ø10 x 100	✓								
	THA10120	Ø10 x 120	✓	17,99	8,77	<u>18,27</u>	17,10	12,59	6,14	<u>18,27</u>	11,97

*Ø5 Assessed only for use in concrete and in precast prestressed hollow core slabs for redundant non-structural systems

General Parameter				Non-cracked concrete				Cracked concrete			
Family	Code	Size	ETA Assessed	Tension $N_{Rk, ucr}$		Shear $V_{Rk, ucr}$		Tension $N_{Rk, ucr}$		Shear $V_{Rk, ucr}$	
THT	THT06040	Ø6 x 40	✓	--	2,78	--	<u>8,35</u>	--	2,54	--	6,24
	THT06050	Ø6 x 50	✓	--	2,78	--	<u>8,35</u>	--	2,54	--	6,24
	THT06060	Ø6 x 60	✓	9,25	2,78	<u>8,35</u>	<u>8,35</u>	6,47	2,54	7,44	6,24
THP	THP05040	Ø5 x 40	✓*	--	4,47	--	4,47	--	3,13	--	3,13
	THP05060	Ø5 x 60	✓*	6,79	4,47	<u>5,46</u>	4,47	4,75	3,13	4,75	3,13
	THP06040	Ø6 x 40	✓	--	2,78	--	<u>8,35</u>	--	2,54	--	6,24
	THP06050	Ø6 x 50	✓	--	2,78	--	<u>8,35</u>	--	2,54	--	6,24
	THP06060	Ø6 x 60	✓	9,25	2,78	<u>8,35</u>	<u>8,35</u>	6,47	2,54	7,44	6,24
	THP06080	Ø6 x 80	✓								
	THP06100	Ø6 x 100	✓								
	THP08060	Ø8 x 60	✓	--	6,28	--	<u>13,05</u>	--	4,39	--	9,49
	THP08080	Ø8 x 80	✓	11,77	6,28	<u>13,05</u>	<u>13,05</u>	8,24	4,39	10,46	9,49
TFF	TFF06035	Ø6 x 35 (M8-M10)	✓	--	2,78	--	--	--	2,65	--	--
	TFF06055	Ø6 x 55 (M8-M10)	✓	9,25	--	--	--	6,47	--	--	--
TFM	TFM06035	Ø6 x 35 (M8)	✓	--	2,78	--	--	--	2,54	--	--
	TFM06055	Ø6 x 55 (M10)	✓	9,25	--	--	--	6,47	--	--	--
TFS	TFS06100	Ø6 x 100 (M8)	✓	9,25	2,78	<u>8,35</u>	<u>8,35</u>	6,47	2,54	7,44	6,24
	TFS06120	Ø6 x 120 (M8)	✓								
	TFS08110	Ø8 x 110 (M10)	✓	11,77	6,28	<u>13,05</u>	<u>13,05</u>	8,24	4,39	10,46	9,49
	TFS08130	Ø8 x 130 (M10)	✓								
	TFS10120	Ø10 x 120 (M12)	✓								
	TFS10140	Ø10 x 140 (M12)	✓	14,67	8,77	<u>18,27</u>	17,10	10,27	6,14	13,56	11,97

*Ø5 Assessed only for use in concrete and in precast prestressed hollow core slabs for redundant non-structural systems

5.3 MAXIMUM LOADS RECOMMENDED (STRUCTURAL APPLICATION) [kN] (with $\gamma_F= 1.4$)

General Parameter				Non-cracked concrete				Cracked concrete			
Family	Code	Size	ETA Assessed	Tension $N_{Rk, ucr}$		Shear $V_{Rk, ucr}$		Tension $N_{Rk, ucr}$		Shear $V_{Rk, ucr}$	
				($h_{ef, std}$)	($h_{ef, red}$)	($h_{ef, std}$)	($h_{ef, red}$)	($h_{ef, std}$)	($h_{ef, red}$)	($h_{ef, std}$)	($h_{ef, red}$)
THE	THE05040	Ø5 x 40	✓*	--	3,20	--	3,20	--	2,24	--	2,24
	THE05050	Ø5 x 50	✓*	4,85	3,20	<u>3,90</u>	3,20	3,40	2,24	3,40	2,24
	THE05060	Ø5 x 60	✓*								
	THE05080	Ø5 x 80	✓*								
	THE05100	Ø5 x 100	✓*								
	THE06040	Ø6 x 40	✓	--	1,98	--	<u>5,97</u>	--	1,81	--	4,46
	THE06050	Ø6 x 50	✓	--		--		--			
	THE06060	Ø6 x 60	✓	6,61	1,98	<u>5,97</u>	<u>5,97</u>	4,62	1,81	5,32	4,46
	THE06070	Ø6 x 70	✓								
	THE06080	Ø6 x 80	✓								
	THE06100	Ø6 x 100	✓								
	THE06120	Ø6 x 120	✓	--	4,48	--	<u>9,32</u>	--	3,14	--	6,78
	THE08055	Ø8 x 55	✓								
	THE08060	Ø8 x 60	✓								
	THE08070	Ø8 x 70	✓								
	THE08080	Ø8 x 80	✓	8,41	4,48	<u>9,32</u>	<u>9,32</u>	5,88	3,14	7,47	6,78
	THE08090	Ø8 x 90	✓								
	THE08100	Ø8 x 100	✓								
	THE08110	Ø8 x 110	✓								
	THE08120	Ø8 x 120	✓								
	THE08140	Ø8 x 140	✓								
	THE10060	Ø10 x 60	✓	--	6,26	--	12,21	--	4,38	--	8,55
	THE10070	Ø10 x 70	✓	--		--		--			
	THE10080	Ø10 x 80	✓	--		--		--			
	THE10090	Ø10 x 90	✓	12,85	6,26	<u>13,05</u>	12,21	8,99	4,38	<u>13,05</u>	8,55
	THE10100	Ø10 x 100	✓								
	THE10120	Ø10 x 120	✓								
	THE10140	Ø10 x 140	✓								
	THE12080	Ø12 x 80	✓	--	10,35	--	<u>17,73</u>	--	7,24	--	16,88
	THE12090	Ø12 x 90	✓	--		--		--			
	THE12110	Ø12 x 110	✓	17,87	10,35	<u>17,73</u>	<u>17,73</u>	12,51	7,24	<u>17,73</u>	16,88
	THE12130	Ø12 x 130	✓								
THE12150	Ø12 x 150	✓									
THE14080	Ø14 x 80	✓	--	10,35	--	<u>25,10</u>	--	7,24	--	18,47	
THE14100	Ø14 x 100	✓	--		--		--				
THE14120	Ø14 x 120	✓	20,67	10,35	<u>25,10</u>	<u>25,10</u>	14,47	7,24	<u>25,10</u>	18,47	
THE14130	Ø14 x 130	✓									
THE14140	Ø14 x 140	✓									
THE14160	Ø14 x 160	✓									
THE16100	Ø16 x 100	✓	--	--	--	--	14,47	7,24	<u>27,60</u>	15,50	
THE16150	Ø16 x 150	✓	20,67	10,35	<u>27,60</u>	22,14					
THE18100	Ø18 x 100	✓	--	13,57	--	36,10	--	9,50	--	25,27	
THE18130	Ø18 x 130	✓	--		--		--				
THE18160	Ø18 x 160	✓	27,77	13,57	<u>38,47</u>	36,10	19,44	9,50	<u>38,47</u>	25,27	
THE18180	Ø18 x 180	✓									
THE18200	Ø18 x 200	✓									

*Ø5 Assessed only for use in concrete and in precast prestressed hollow core slabs for redundant non-structural systems

General Parameter				Non-cracked concrete				Cracked concrete			
Family	Code	Size	ETA Assessed	Tension $N_{Rk,ucr}$		Shear $V_{Rk,ucr}$		Tension $N_{Rk,ucr}$		Shear $V_{Rk,ucr}$	
				($h_{ef, std}$)	($h_{ef, red}$)	($h_{ef, std}$)	($h_{ef, red}$)	($h_{ef, std}$)	($h_{ef, red}$)	($h_{ef, std}$)	($h_{ef, red}$)
TFE	TFE05040	Ø5 x 40	✓*	--	3,20	--	3,20	--	2,24	--	2,24
	TFE05050	Ø5 x 50	✓*	4,85	3,20	<u>3,90</u>	3,20	3,40	2,24	3,40	2,24
	TFE05060	Ø5 x 60	✓*								
	TFE05080	Ø5 x 80	✓*								
	TFE05100	Ø5 x 100	✓*								
	TFE06040	Ø6 x 40	✓	--	1,98	--	<u>5,97</u>	--	1,81	--	4,46
	TFE06050	Ø6 x 50	✓								
	TFE06060	Ø6 x 60	✓	6,61	1,98	<u>5,97</u>	<u>5,97</u>	4,62	1,81	5,32	4,46
	TFE06070	Ø6 x 70	✓								
	TFE06080	Ø6 x 80	✓								
	TFE06100	Ø6 x 100	✓								
	TFE06120	Ø6 x 120	✓	--	4,48	--	<u>9,32</u>	--	3,14	--	6,78
	TFE08055	Ø8 x 55	✓								
	TFE08060	Ø8 x 60	✓								
	TFE08070	Ø8 x 70	✓								
	TFE08080	Ø8 x 80	✓	8,41	4,48	<u>9,32</u>	<u>9,32</u>	5,88	3,14	7,47	6,78
	TFE08090	Ø8 x 90	✓								
	TFE08100	Ø8 x 100	✓								
	TFE08110	Ø8 x 110	✓								
	TFE08120	Ø8 x 120	✓								
	TFE08140	Ø8 x 140	✓								
	TFE10060	Ø10 x 60	✓	--	6,26	--	12,21	--	4,38	--	8,55
	TFE10070	Ø10 x 70	✓								
	TFE10080	Ø10 x 80	✓								
	TFE10090	Ø10 x 90	✓								
	TFE10100	Ø10 x 100	✓	12,85	6,26	<u>13,05</u>	12,21	8,99	4,38	<u>13,05</u>	8,55
	TFE10120	Ø10 x 120	✓								
	TFE10140	Ø10 x 140	✓								
	TFE12080	Ø12 x 80	✓								
	TFE12090	Ø12 x 90	✓								
	TFE12110	Ø12 x 110	✓	17,87	10,35	<u>17,73</u>	<u>17,73</u>	12,51	7,24	<u>17,73</u>	16,88
	TFE12130	Ø12 x 130	✓								
	TFE12150	Ø12 x 150	✓								
	TFE14080	Ø14 x 80	✓	--	10,35	--	<u>25,10</u>	--	7,24	--	18,47
TFE14100	Ø14 x 100	✓									
TFE14120	Ø14 x 120	✓									
TFE14130	Ø14 x 130	✓									
TFE14140	Ø14 x 140	✓	20,67	10,35	<u>25,10</u>	<u>25,10</u>	14,47	7,24	<u>25,10</u>	18,47	
TFE14160	Ø14 x 160	✓									
TFE16100	Ø16 x 100	✓	--	--	--	--	14,47	7,24	<u>27,60</u>	15,50	
TFE16150	Ø16 x 150	✓									
TFE18100	Ø18 x 100	✓	--	13,57	--	36,10	--	9,50	--	25,27	
TFE18130	Ø18 x 130	✓									
TFE18160	Ø18 x 160	✓									
TFE18180	Ø18 x 180	✓									
TFE18200	Ø18 x 200	✓	27,77	13,57	<u>38,47</u>	36,10	20,26	9,50	<u>38,47</u>	25,27	
THA	THA05040	Ø5 x 40	✓*	--	3,20	--	3,20	--	2,24	--	2,24
	THA05060	Ø5 x 60	✓*	4,85	3,20	<u>3,90</u>	3,20	3,40	2,24	3,40	2,24
	THA05080	Ø5 x 80	✓*								
	THA05100	Ø5 x 100	✓*								
	THA06045	Ø6 x 45	✓	--	1,98	--	<u>5,97</u>	--	1,81	--	4,46
	THA06050	Ø6 x 50	✓								
	THA06060	Ø6 x 60	✓	6,61	1,98	<u>5,97</u>	<u>5,97</u>	4,62	1,81	5,32	4,46
	THA06080	Ø6 x 80	✓								
	THA06100	Ø6 x 100	✓								
	THA06120	Ø6 x 120	✓								
	THA06140	Ø6 x 140	✓	--	4,48	--	<u>9,32</u>	--	3,14	--	6,78
	THA08060	Ø8 x 60	✓								
	THA08080	Ø8 x 80	✓	8,41	4,48	<u>9,32</u>	<u>9,32</u>	5,88	3,14	7,47	6,78
	THA08100	Ø8 x 100	✓								
	THA08120	Ø8 x 120	✓								
	THA10100	Ø10 x 100	✓								
THA10120	Ø10 x 120	✓	12,85	6,26	<u>13,05</u>	12,21	8,99	4,38	<u>13,05</u>	8,55	

*Ø5 Assessed only for use in concrete and in precast prestressed hollow core slabs for redundant non-structural systems

General Parameter				Non-cracked concrete				Cracked concrete			
Family	Code	Size	ETA Assessed	Tension $N_{Rk, ucr}$		Shear $V_{Rk, ucr}$		Tension $N_{Rk, ucr}$		Shear $V_{Rk, ucr}$	
				($h_{ef, std}$)	($h_{ef, red}$)	($h_{ef, std}$)	($h_{ef, red}$)	($h_{ef, std}$)	($h_{ef, red}$)	($h_{ef, std}$)	($h_{ef, red}$)
THT	THT06040	Ø6 x 40	✓	--	1,98	--	<u>5,97</u>	--	1,81	--	4,46
	THT06050	Ø6 x 50	✓	--	--	--	--	--	--	--	--
	THT06060	Ø6 x 60	✓	6,61	1,98	<u>5,97</u>	<u>5,97</u>	4,62	1,81	5,32	4,46
THP	THP05040	Ø5 x 40	✓*	--	3,20	--	3,20	--	2,24	--	2,24
	THP05060	Ø5 x 60	✓*	4,85	3,20	<u>3,90</u>	3,20	3,40	2,24	3,40	2,24
	THP06040	Ø6 x 40	✓	--	--	--	--	--	--	--	--
	THP06050	Ø6 x 50	✓	--	1,98	--	<u>5,97</u>	--	1,81	--	4,46
	THP06060	Ø6 x 60	✓	--	--	--	--	--	--	--	--
	THP06080	Ø6 x 80	✓	6,61	1,98	<u>5,97</u>	<u>5,97</u>	4,62	1,81	5,32	4,46
	THP06100	Ø6 x 100	✓	--	--	--	--	--	--	--	--
	THP08060	Ø8 x 60	✓	--	4,48	--	<u>9,32</u>	--	3,14	--	6,78
	THP08080	Ø8 x 80	✓	8,41	4,48	<u>9,32</u>	<u>9,32</u>	6,15	3,14	7,47	6,78
TFF	TFF06035	Ø6 x 35 (M8-M10)	✓	--	1,98	--	--	--	1,81	--	--
	TFF06055	Ø6 x 55 (M8-M10)	✓	6,61	--	--	--	4,62	--	--	--
TFM	TFM06035	Ø6 x 35 (M8)	✓	--	1,98	--	--	--	1,81	--	--
	TFM06055	Ø6 x 55 (M10)	✓	6,61	--	--	--	4,62	--	--	--
TFS	TFS06100	Ø6 x 100 (M8)	✓	6,61	1,98	<u>5,97</u>	<u>5,97</u>	4,62	1,81	5,32	4,46
	TFS06120	Ø6 x 120 (M8)	✓	--	--	--	--	--	--	--	--
	TFS08110	Ø8 x 110 (M10)	✓	8,41	4,48	<u>9,32</u>	<u>9,32</u>	5,88	3,14	7,47	6,78
	TFS08130	Ø8 x 130 (M10)	✓	--	--	--	--	--	--	--	--
	TFS10120	Ø10 x 120 (M12)	✓	10,48	6,26	<u>13,05</u>	12,21	7,34	4,38	9,68	8,55
	TFS10140	Ø10 x 140 (M12)	✓	--	--	--	--	--	--	--	--

*Ø5 Assessed only for use in concrete and in precast prestressed hollow core slabs for redundant non-structural systems

PULL OUT INCREASING FACTOR FOR TENSION LOADS IN HIGH RESISTANCE CONCRETE ψ_c															
Diameter	Ø5		Ø6		Ø8		Ø10			Ø12		Ø14		Ø18	
Installation depth	($h_{ef, red}$)	($h_{ef, std}$)	($h_{ef, red}$)	($h_{ef, std}$)	($h_{ef, red}$)	($h_{ef, std}$)	($h_{ef, 1}$)	($h_{ef, 2}$)	($h_{ef, 3}$)	($h_{ef, red}$)	($h_{ef, std}$)	($h_{ef, red}$)	($h_{ef, std}$)	($h_{ef, red}$)	($h_{ef, std}$)
C30/37	1,00	1,00	1,16	1,22	1,21	1,22	1,22	1,17	1,22	1,16	1,22	1,21	1,20	1,22	1,17
C40/50	1,00	1,00	1,28	1,41	1,39	1,41	1,41	1,30	1,41	1,29	1,41	1,39	1,37	1,40	1,32
C50/60	1,00	1,00	1,39	1,58	1,54	1,58	1,58	1,42	1,58	1,40	1,58	1,55	1,51	1,57	1,42

6. OFFICIAL DOCUMENTATION

The following documents are available on our official website www.indexfix.com:

- European assessment ETA 20/0046 for Installation in cracked and non-cracked concrete according to guideline EAD 330232-00-0601, option 1, from Ø6 to Ø18.
- European assessment ETA 20/0494 for use in concrete and prestressed hollow core slabs for redundant non-structural systems according to guideline EAD 330747-00-0601 from Ø5 to Ø6.
- Declaration of performance DoP THE.
- VdS certificate CEA 4001:2021-01(07) *Guidelines for sprinklers systems. Planning and installation for applications of water extinguishing systems on concrete elements* from Ø6 to Ø18.
- Available in the anchor design software INDEXcal.